

# THE ICE DAM COMETH!

## WHAT'S A HOMEOWNER TO DO?

Remember those snowy winters? Beautiful snow and ice made for great winter beauty and fun. But then, as the weather warmed a little, that beauty became an ugly, damaging, watery mess inside some homes. In many cases, ice dams were the culprit. Let's talk about winter ice damming and how to prevent problems.

### WHAT IS AN ICE DAM?

An ice dam is a ridge of ice that builds up along the edge of a roof. The ice creates a dam that backs water up and under the roof shingles. Once the water is deep enough, it penetrates the roofing system and creates water damage inside the home. (SEE FIGURE R002)

To recognize an ice dam, look for a bulge of ice attached to the eaves or overhang of a roof. There may be icicles ("Aren't they pretty!") hanging from the edge, and you may see stains on the siding. The rain gutters may be overflowing with ice.

Often, the bulge of ice is covered with several inches of snow, so you may not see it. Under the buildup of frozen snow is the melting snow and ice—water that is

entering your home. If interior damage has already occurred, you will see a wet ceiling and wall or water flowing into windows.

### RELATED DAMAGE

Beneath the ice dam, undetectable damage is occurring in the attic and wall cavities. The wood framing is wet and may be rotting. Insulation is soaked, which makes it inefficient. Mildew and mold can grow in hidden spots, causing odors and other problems inside your home.

Soaked framing and insulation will take a long time to dry out and will continue to contribute to wall damage and interior moisture problems. Uncorrected, the water can cause serious structural damage.

### UNDER COVER: A CLOSE LOOK AT THE CAUSE

Ice dam problems are most common in snowbelt regions. They begin when snow accumulates on a roof. Generally, deeper snow and colder temperatures increase the formation of ice dams. North or north-west winds usually accompany snowfalls, so more snow is deposited on north and west roof planes. Complex roof structures that trap snow compound its depth and the problems it creates.

Once the snow has built up on the roof, it acts as an effective insulator. (Light snow has a insulation value of about R-1 per inch.) Heat from the attic warms the underside of the roof and melts the bottom snow into a slush/ice/water mixture. This mixture slides under the snow cover and runs down the roof till it meets a cold surface like the overhang. The slush then re-freezes. As more slush accumulates, the layer becomes thicker and thicker, creating an ice dam. All of this action occurs hidden from view under the snow cover.

Once the ice dam is high enough to overcome the pitch of the roof, water seeps under asphalt shingles. Standard roof shingle construction is not designed to resist the attack of water pooling on its surface. The

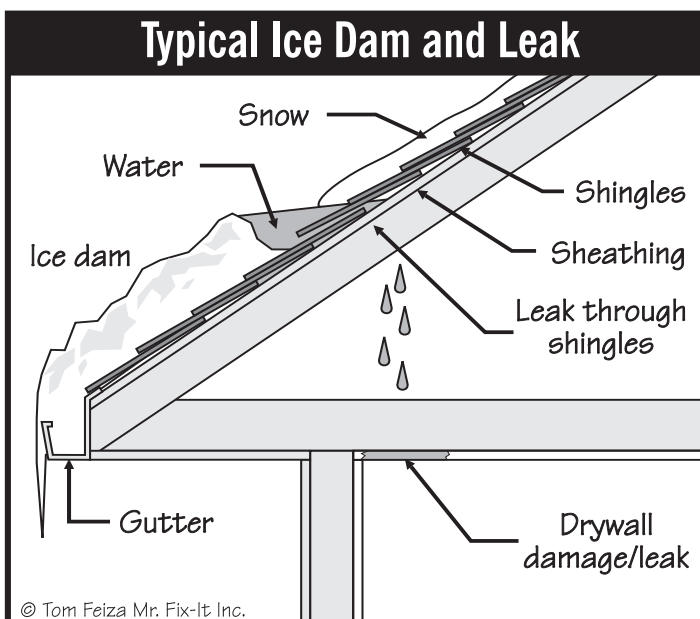

© Tom Feiza Mr. Fix-It Inc.

R002

alternate freezing and thawing that occurs under these conditions can increase the magnitude of roof leaks. Once the water has penetrated the shingles, it flows under the siding and eaves and leaks through the framing into your home.

## “IT NEVER HAPPENED IN THE GOOD OLD DAYS”

What seasoned homeowners say is true: ice dams were not a problem before the '30s or '40s. Back then, builders used a totally different type of construction. Homes had steeply pitched roofs. Wooden shingles were installed over spaced boards for sheathing so the shingles could breathe and dry. Spaces between the shingles and deck ventilated the attic and cooled the roof deck. Many families did not fully heat the home's second story, or they heated it just enough to keep water from freezing in a drinking glass. (I grew up in one of those homes.)

In newer homes with good heating systems, the attic was often excessively warm because energy was cheap and so homes were not well insulated. This excessive heat rapidly melted the snow on the roof. Usually a small line of ice existed only at the gutter or eaves, and even that cleared on warmer days. Water penetration did not linger, and ice dams as we know them today did not exist.

Then, in the 1930s and '40s, we began to tighten up our homes and use new materials. Roofers began applying asphalt shingles, and building paper, plywood, insulation, and vapor barriers came into use. Central heating was made very effective, and all the living spaces were heated. These changes triggered new problems with moisture and ice dams. Attic ventilation slowly became the standard.

## GOOD ADVICE ON PREVENTING ICE

To prevent ice dams, your first step should be to eliminate heat buildup in the attic space below the roof deck. You can do this by (1) improving insulation (2) stopping air “bypass”, and (3) increasing ventilation. The temperature in the attic space below the roofing should be nearly the same as the outside temperature. This “cold roof” concept has proven effective in modern construction.

### PHASE ONE: THE INSULATION SITUATION

Add insulation to improve the thermal envelope and

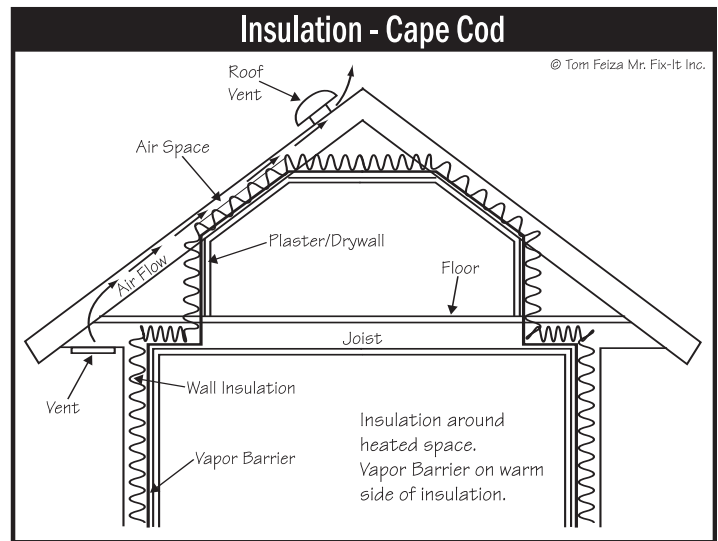

1001

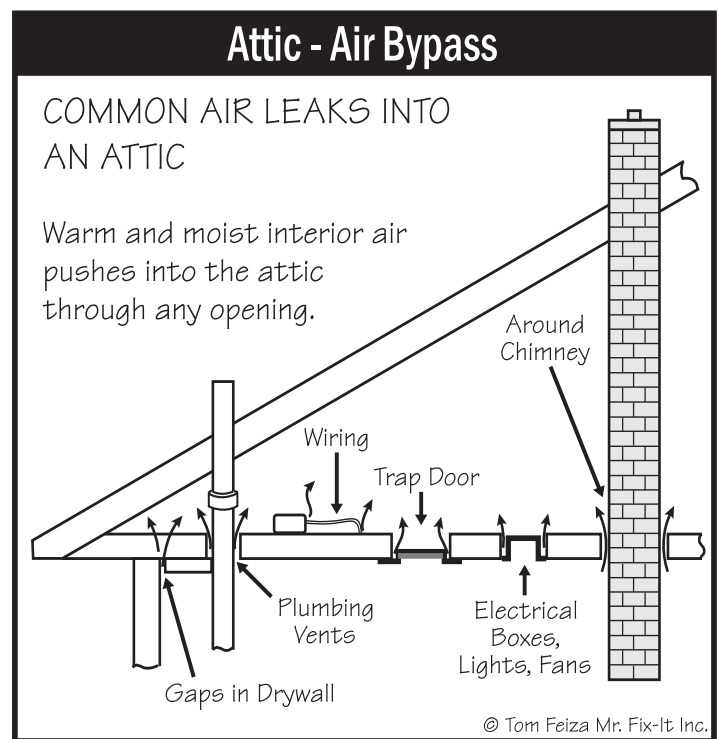

1005

slow heat transfer to the attic. Surfaces between the attic and the heated living spaces beneath it should be insulated to approximately R- 38 or more. R-38 is equivalent to approximately 12 inches of quality Fiberglas bat insulation. Eliminate any gaps or openings in the insulation, and insulate all access doors to the attic, too. (SEE FIGURE 1001)

### PHASE TWO: STOP HOT AIR “BYPASS”

You must also seal any opening that allows heated air to “bypass” the insulation and rise into the attic. The warm air in your home will always try to rise and will push through any small opening. Not only can this

warm air movement create major heat losses from the living space, it's also a major source of heat and moisture problems in the attic. (SEE FIGURE I005)

The attic door should be weather-stripped even better than an exterior door. All penetrations of wiring, piping, and wood framing into the attic should be sealed with caulk, sheet metal, or expandable foam insulation. The spaces around most chimneys should be sealed with non-flammable material.

Exhaust fans should not empty into the attic, and the area between the frame of the fan and the ceiling should be tightly sealed. (SEE FIGURE V008) If there are heating ducts in the attic, seal and insulate all duct surfaces exposed to attic air. Look for kitchen or bath soffit spaces that may have gaps and openings in their plaster or drywall.

attic roof. Most experts agree that the best system is a continuous soffit and ridge vent, although this is not always possible or necessary. (SEE FIGURE V005)

The MINIMUM ventilation ratio of 1 square foot of ventilation for 300 square feet of attic space (1/300) is a guideline for newer homes with effective vapor barriers. (SEE FIGURE V042) Older homes need a MINIMUM ventilation ratio of 1/150. Half of the ventilation should be in the ridge and 25 percent in each soffit. This is the ideal situation that can rarely be accomplished. When in doubt, add more ventilation. In general, a continuous ridge and soffit vent provides three times the 1/300 ventilation ratio and performs very well. Extra ventilation can't hurt unless you have excessive air bypass that allows excessive warm air to be drawn into the attic.

Remember, a 1 foot by 1 foot grill does not provide a full square foot of ventilation. The grill and screen covering detracts from the "free vent" area by as much as 50 percent. Sometimes the free vent area rating appears on the grill. When in doubt, assume that 50 percent or less of the vent is available as a free vent area. (SEE FIGURE V027)

### WHEN ICE DAMS DO OCCUR

If ice dams have already developed on your house,

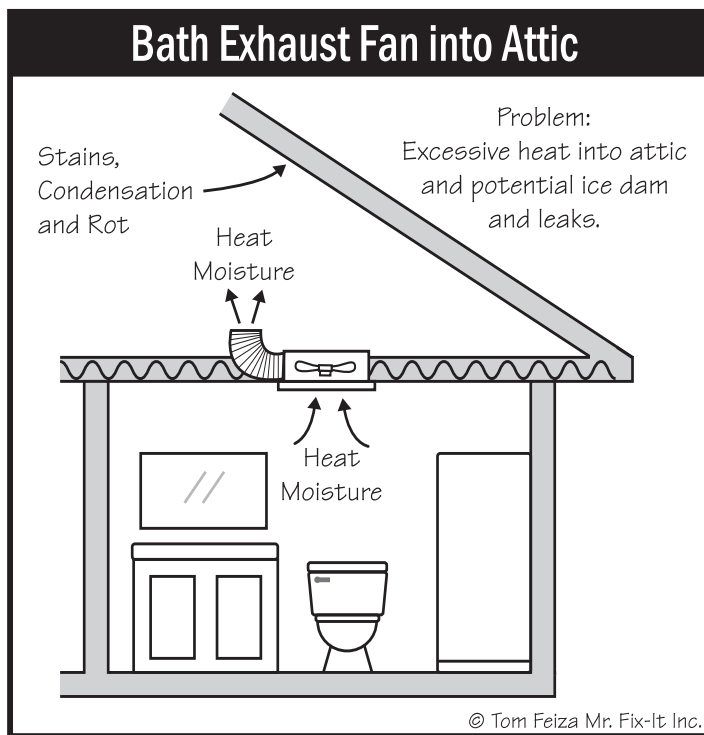

V008

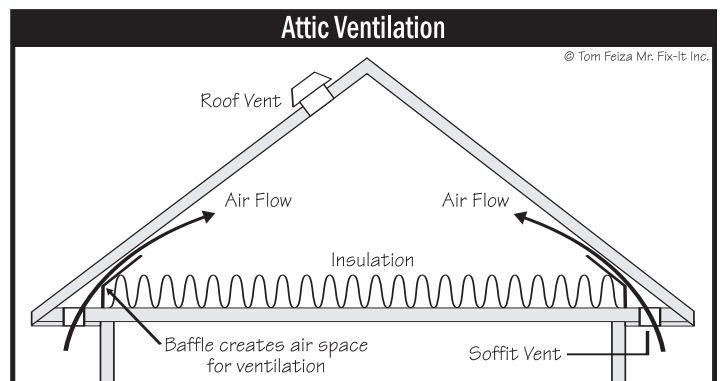

V002

### PHASE THREE: IMPROVE VENTILATION

Good ventilation is the second half of your ice dam prevention strategy. As you inspect and fix the attic insulation, avoid blocking any vents with insulation. (SEE FIGURE V002)

Increasing the attic's ventilation will cool the space and remove unwanted moisture. The best ventilation system is balanced between low-intake ventilation from the overhangs (soffit) and high-exhaust vents on the

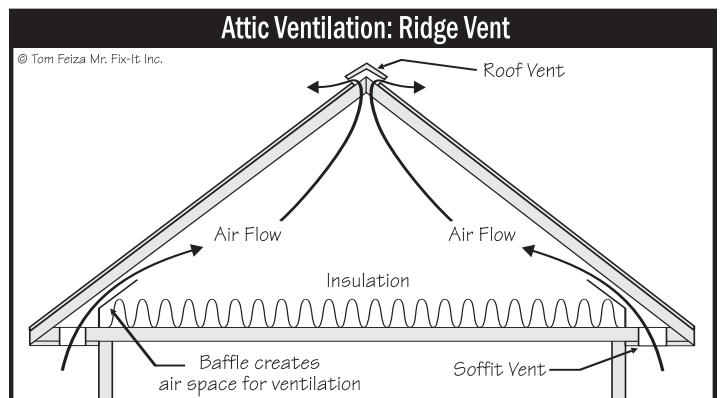

V005

## Attic Ventilation Requirements - Typical

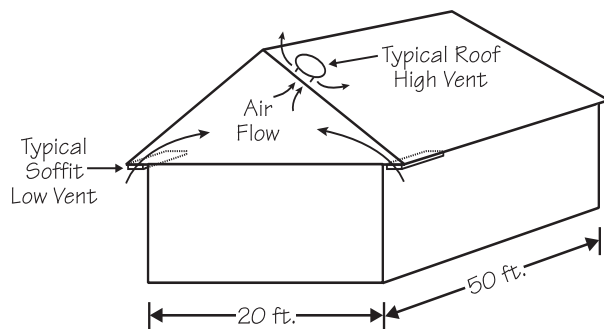

Attic Area = 20 x 50 feet = 1000 sq. ft.

NFA

Min. Ventilation w/o Vapor Barrier =  $\frac{1000}{150} = 6.6$  sq. ft. = 960 sq. in.

Min. Ventilation w/ Vapor Barrier =  $\frac{1000}{300} = 3.3$  sq. ft. = 480 sq. in.

Typical attic ventilation requirements are based on the attic area divided by 300 or 150 depending on the type of construction. 50% of vent area must be high on the roof and 50% low on the roof. NFA is "Net Free Area" of the vent. The actual "free vent" area is reduced by screens and louvers on the vent.

© Tom Feiza Mr. Fix-It Inc.

VO42

## Attic Ventilation Grills - Typical NFA

Typical Undereave Vent

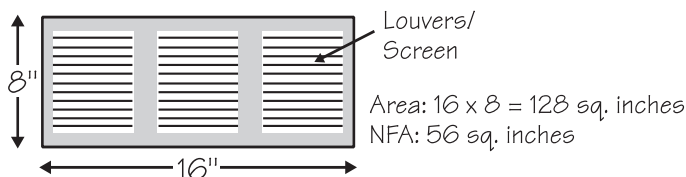

Typical Metal Roof Vent (Round)

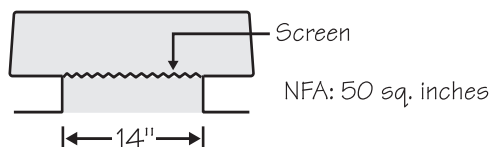

The actual "Net Free Area" (NFA) is reduced significantly by grills and screens. Most vents will have the NFA indicated on the vent. It is often less than 50% of the opening in the sheathing.

© Tom Feiza Mr. Fix-It Inc.

VO27

you may be able to wait out the problem and work on insulation and ventilation in the spring—if the water damage is not excessive. You may reach the damaged area through the attic and try to catch some of the water. You may also wish to punch small or even large holes in the drywall or plaster to drain the water, thus limiting damage.

In severe water damage cases, it is possible to chip away the offending ice down to the roof deck to allow the ice/water to drain. Use caution, however, because removing snow and ice from a pitched roof is a dangerous operation at best. Walking on a frozen roof and chipping away the ice will surely cause some roof damage, but this may seem a reasonable alternative to further interior damage when you see water ruining your fine windows and woodwork.

Melting the ice with snow melting chemicals (not rock salt) is an option in a emergency situation. You can also fill old nylon stocking legs with the snow melt chemical and lay it across the ice dam to cut a groove through the ice. The melting "sock" will continue to keep the groove open as the chemical is activated by moisture. (SEE FIGURE M024)

## Snow Melt Sock - Remove Ice Dam

© Tom Feiza Mr. Fix-It Inc.

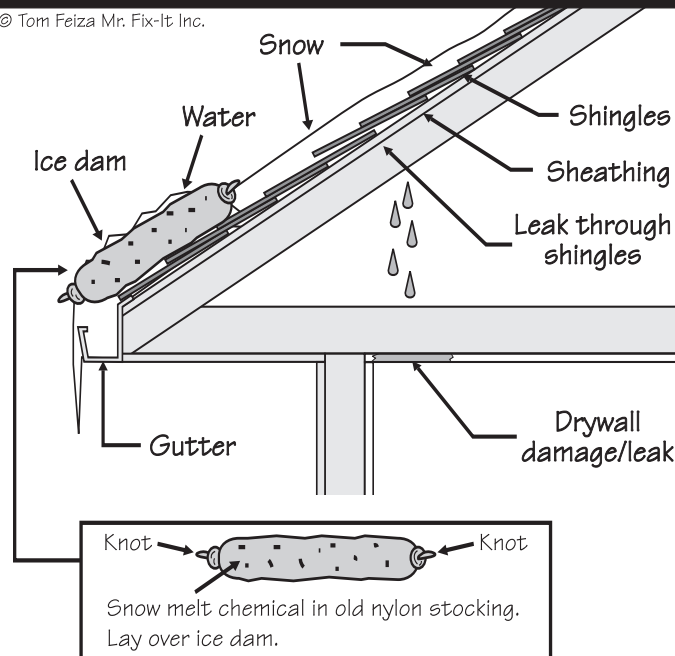

In an emergency, apply snow melt pellets (not rock salt) to ice dam. Or, use pellets in a nylon stocking "sausage" to melt a groove in the ice so water drains.

M024

## PREVENTIVE MEASURES

You may be tempted to use electrical snow- and ice-melt cables, but often these just move the ice dam further up the roof. The cables are hard to maintain, and often they're unsightly. They must be fastened by putting new holes in your roof—not a good idea!

It's possible to remove snow from the problem areas

before an ice dam develops if you can reach the area from the ground or the roof edge. You can buy a long-handled snow rake and carefully remove the snow. Remember, though, that you could easily damage the frozen roof, and it's a cold and dangerous job besides. (SEE FIGURE M023)

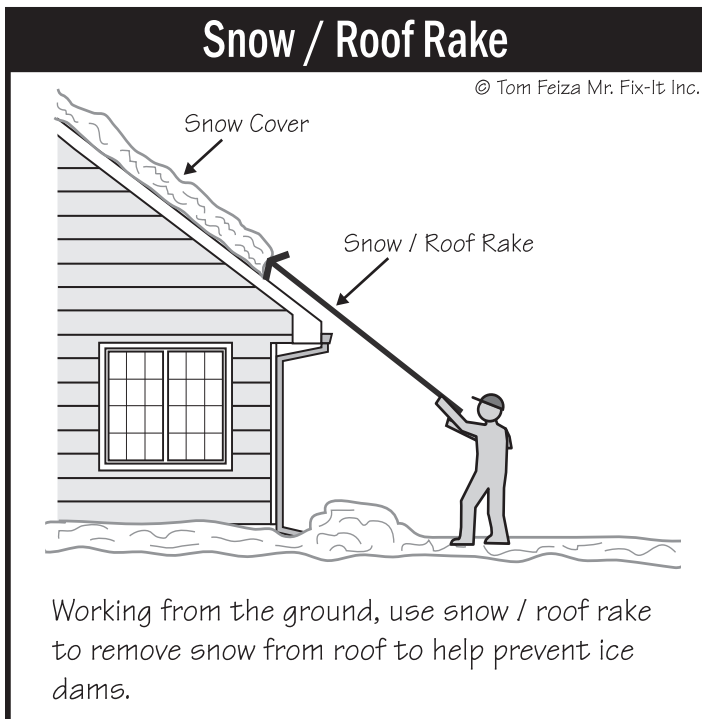

M023

## WATER SHIELD PROVIDES HELP

During major roof repair or replacement, you can add a water shield under the shingles in problem areas like overhangs. The water shield or membrane is a rubber-like adhesive sheet applied to the roof deck under the shingles. The membrane, about as thick as a shingle, is applied as a continuous roll about 36 inches wide. Soft and sticky, it covers nail penetrations and seals the roof deck. If water is forced up under the shingles by an ice dam, the membrane prevents water penetration below the roof deck. The membrane should extend at least two feet into the living space. (SEE FIGURE R007)

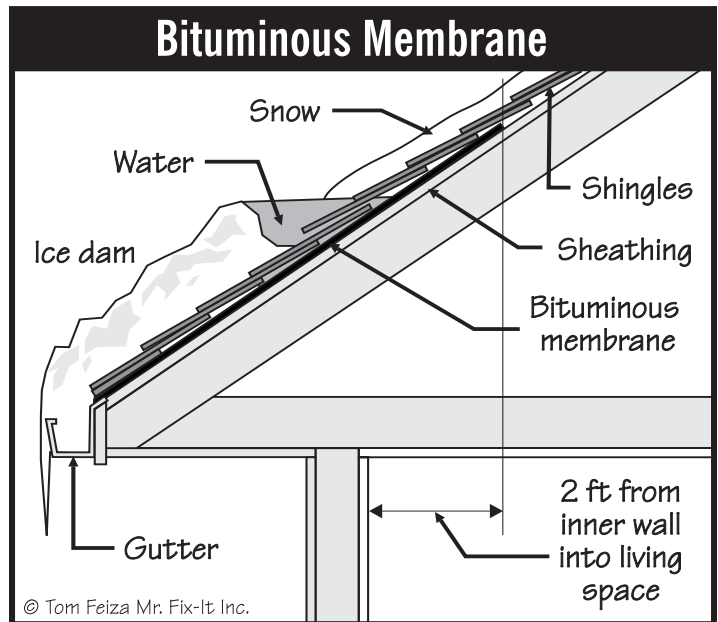

R007

## PROCEED WITH CAUTION

If you have any questions or concerns, consult a professional. Improper insulation or sealing around light fixtures, metal flue pipes, and chimneys can create a fire hazard. Also, ventilation can be tricky to achieve. In general, attics are not friendly places—one misstep and you can fall through the ceiling.

## CONFUSED? WHERE TO GET MORE HELP

All manufacturers of insulation, ventilation, and roofing materials offer technical material. Your local utility or university extension may have free or low-cost information. Or rely on professional contractors for product information and technical literature from manufacturers.

As with any home-related problem, don't panic. If you had minor ice dams once in ten years, I would carefully monitor the problem area and try insulation and ventilation. If you are considering a roof replacement, the continuous membrane under the edge of the roof is good insurance against problems.

## HOME TIPS

Written by Tom Feiza

See Tom's book  
How To Operate Your Home  
(ISBN 09747591-0),  
for great information  
on "operating" a home.

The book is available at  
[www.amazon.com](http://www.amazon.com) or through Tom at:  
[www.howtooperateyourhome.com](http://www.howtooperateyourhome.com)  
or [www.htoyh.com](http://www.htoyh.com)  
262-786-7878.

